

Janson Plate Girder Bridges JSB 200 series

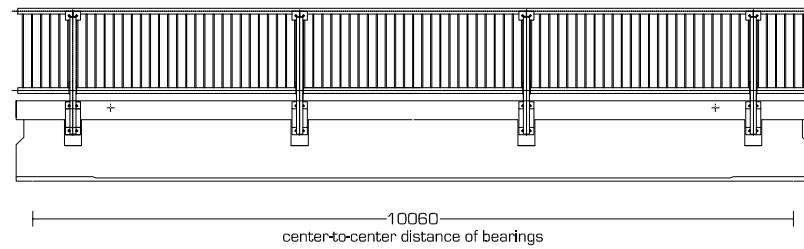

Side view **JSB 200 series - 10,50m** Free span

[1-100]



Example

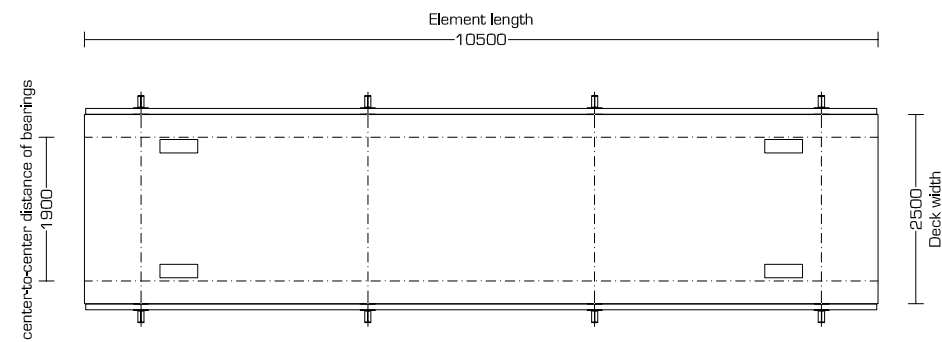

Top view **JSB 200 series - 2,50m** Deck width

[1-100]

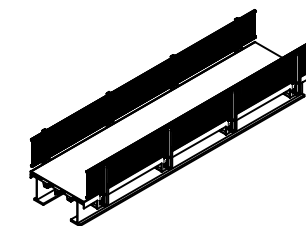

3D

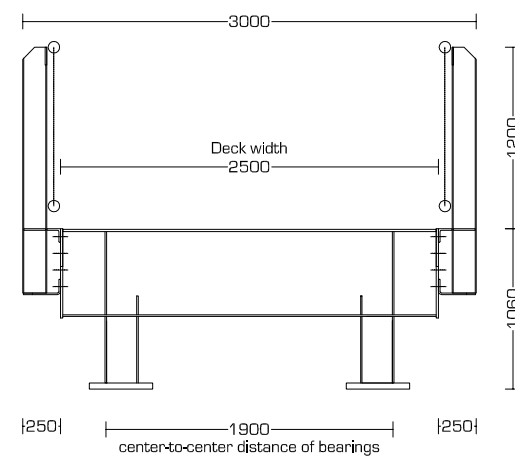

Cross view **JSB 200 series - 1,06m** Construction height

[1-50]

- Element length: 10.500 mm
- Deck width: 2.500 mm
- Construction height: 1.060 mm
- Dead load: 12,7 t
- Load class: EuroCode
- Deck surface: Epoxy resin embedded with aggregate

EXAMPLE DRAWING



www.jansonbridging.com

JSB 200 series - 10,50m x 2,50m

Janson Plate Girder Bridges JSB 200 series

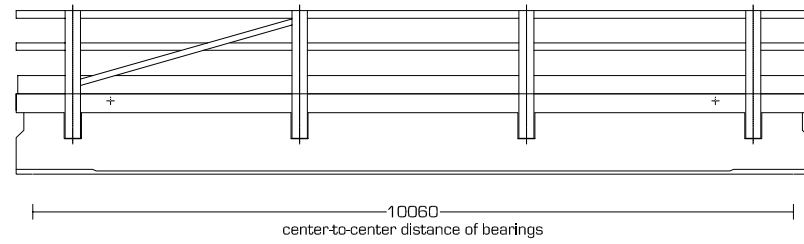

Side view **JSB 200 series - 10,50m** Free span

[1-100]



Example

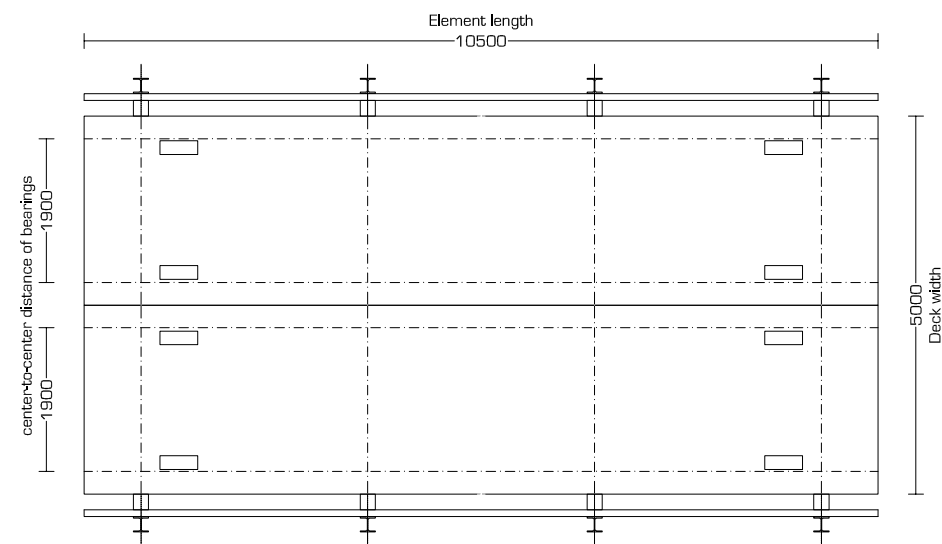

Top view **JSB 200 series - 5,00m** Deck width

[1-100]

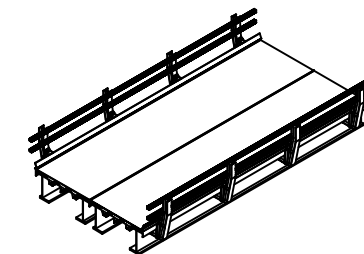

3D

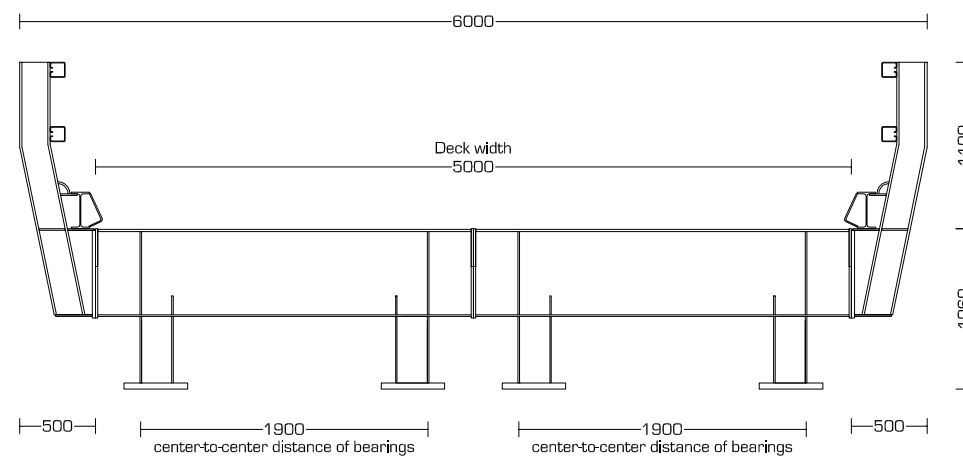

Cross view **JSB 200 series - 1,06m** Construction height

[1-50]

- Element length: 10.500 mm
- Deck width: 5.000 mm
- Construction height: 1.060 mm
- Dead load: 26,1 t
- Load class: EuroCode
- Deck surface: Epoxy resin embedded with aggregate

EXAMPLE DRAWING			
		JANSONBRIDGING <small>COME ACROSS</small>	
www.jansonbridging.com			
JSB 200 series - 10,50m x 5,00m			
Code	Form	Date	Scale
1-100 1-50		2011-09-15	sc

Janson Plate Girder Bridges JSB 200 series

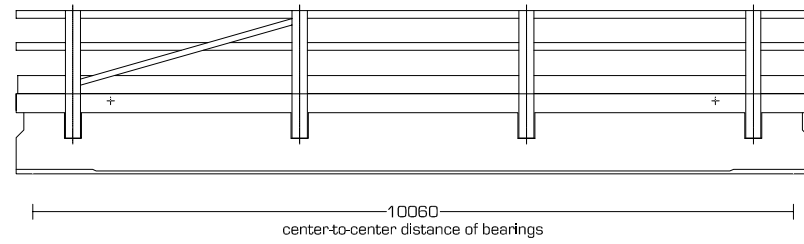

Side view **JSB 200 series - 10,50m** Free span

[1-100]



Example

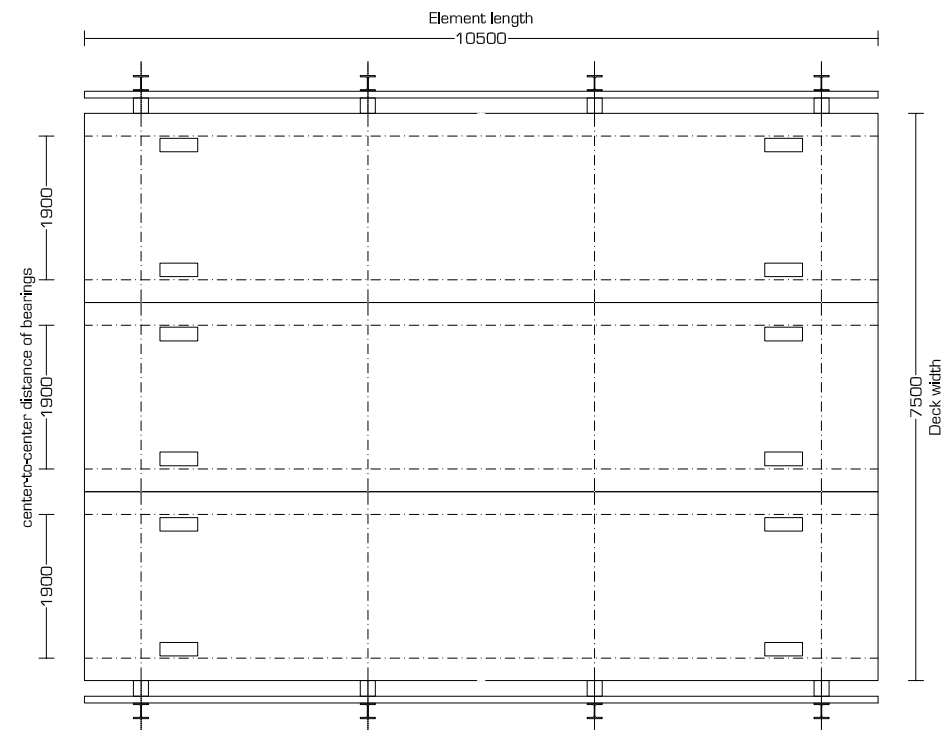

Top view **JSB 200 series - 7,50m** Deck width

[1-100]

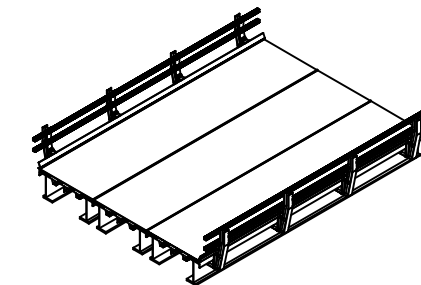

3D

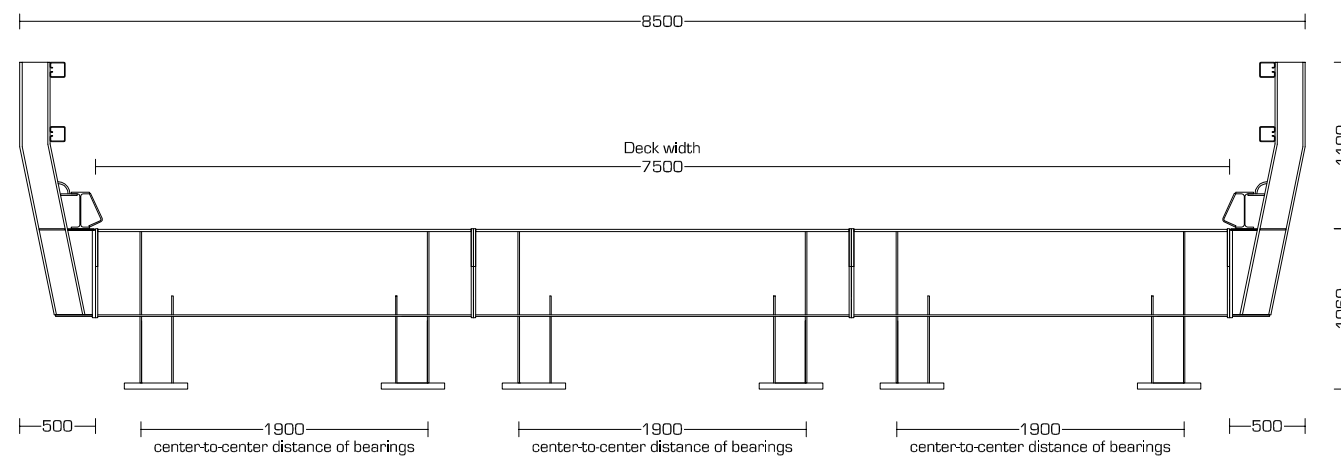

Cross view **JSB 200 series - 1,06m** Construction height

[1-50]

- Element length: 10.500 mm
- Deck width: 7.500 mm
- Construction height: 1.060 mm
- Dead load: 37,6 t
- Load class: EuroCode
- Deck surface: Epoxy resin embedded with aggregate

EXAMPLE DRAWING			
		JANSONBRIDGING COME ACROSS	
www.jansonbridging.com			
JSB 200 series - 10,50m x 7,50m			
Code	Form	Date	Scale
1-100 1-50		2011-09-15	sc