

Janson Plate Girder Bridges **JSB 300 series**

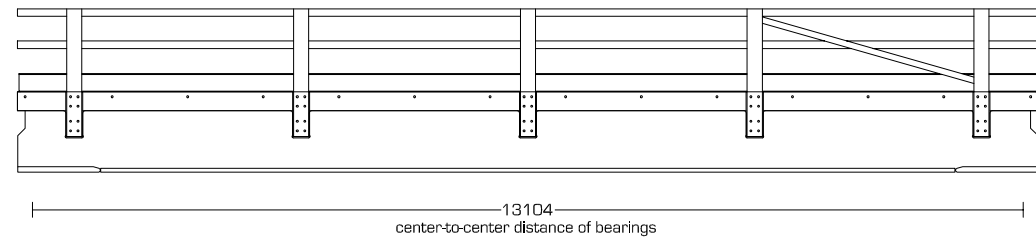

Side view **JSB 300 series - 13,50m** Free span [1-100]



Example

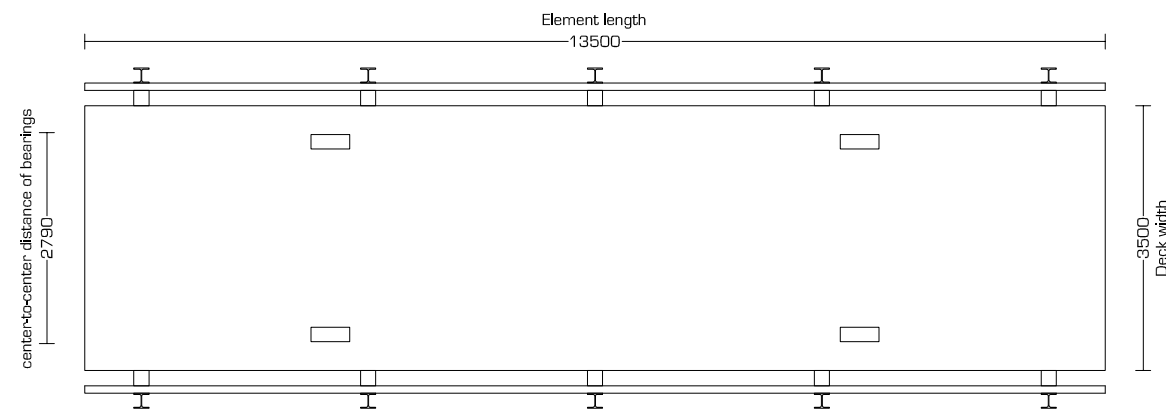

Top view **JSB 300 series - 3,50m** Deck width [1-100]

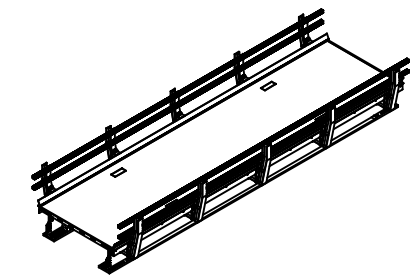

3D

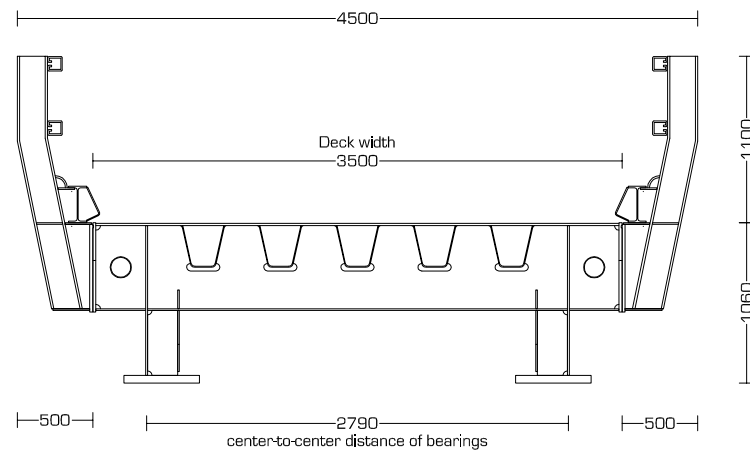

Cross view **JSB 300 series - 1,06m** Construction height [1-50]

- Element length: 13.500 mm
- Deck width: 3.500 mm
- Construction height: 1.060 mm
- Dead load: 24,0 t
- Load class: EuroCode
- Deck surface: Epoxy resin embedded with aggregate

EXAMPLE DRAWING			
		JANSONBRIDGING <small>COME ACROSS</small>	
www.jansonbridging.com			
JSB 300 series - 13,50m x 3,50m			
Scale	Form	Date	Author
1-100 1-50		2011-09-15	sc

Janson Plate Girder Bridges JSB 300 series

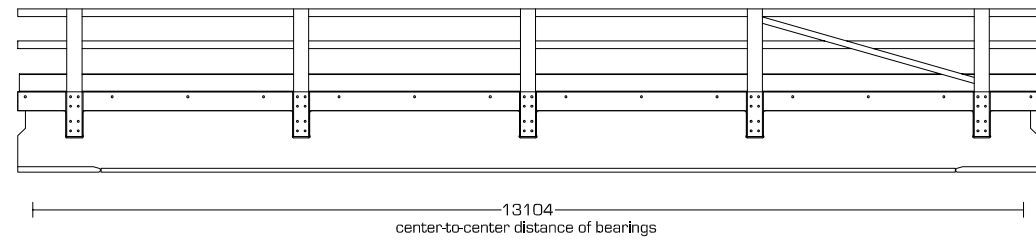

Side view **JSB 300 series - 13,50m** Free span [1-100]



Example

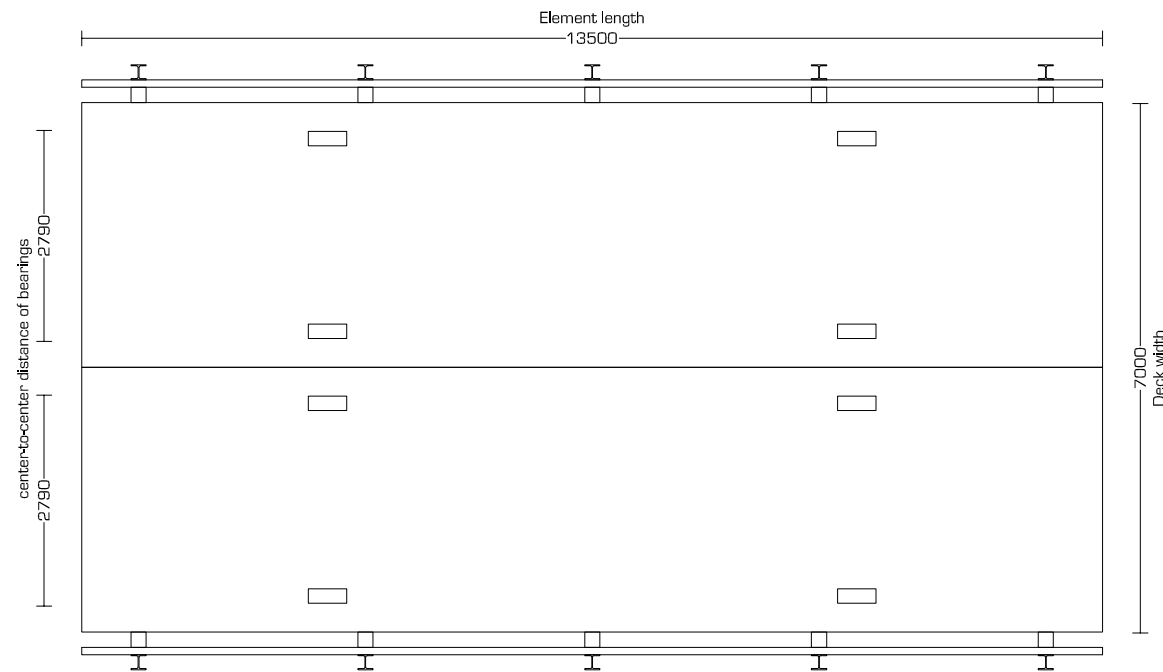

Top view **JSB 300 series - 7,00m** Deck width [1-100]

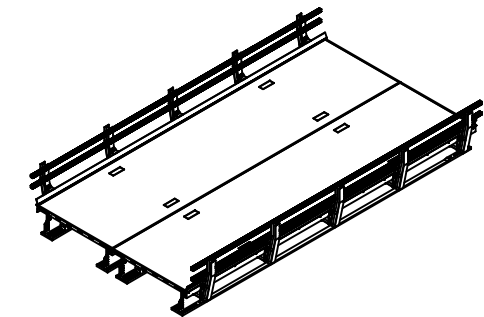

3D

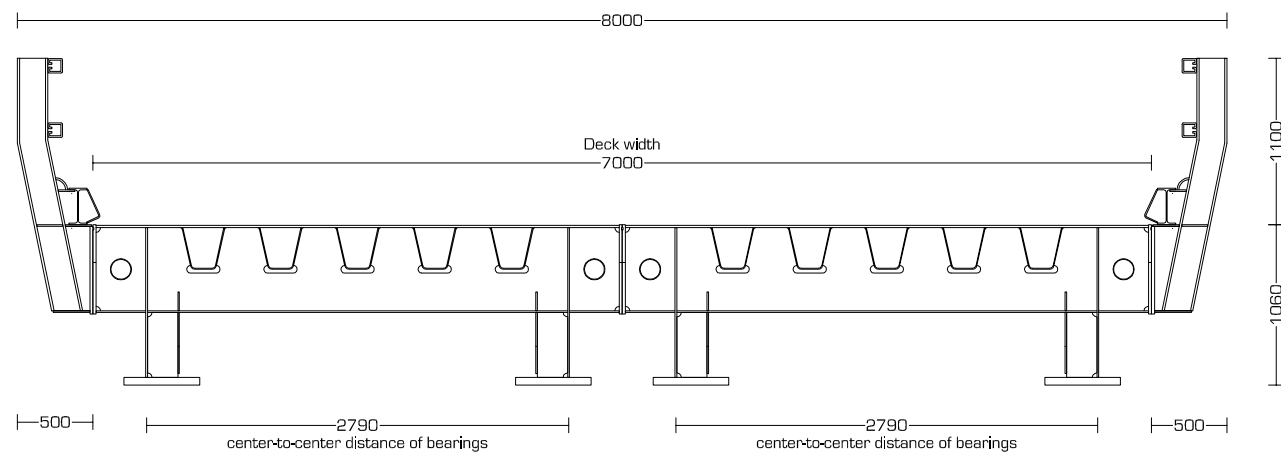

Cross view **JSB 300 series - 1,06m** Construction height [1-50]

- Element length: 13.500 mm
- Deck width: 7.000 mm
- Construction height: 1.060 mm
- Dead load: 44,0 t
- Load class: EuroCode
- Deck surface: Epoxy resin embedded with aggregate

EXAMPLE DRAWING			
		JANSONBRIDGING <small>COME ACROSS</small>	
www.jansonbridging.com			
JSB 300 series - 13,50m x 7,00m			
Scale	Formal	Date	Author
1-100 1-50		2011-09-15	sc

Janson Plate Girder Bridges JSB 300 series

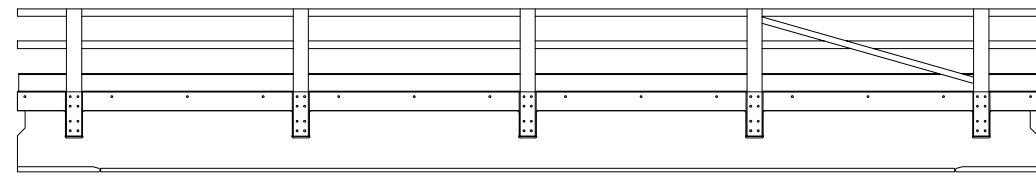

13104
center-to-center distance of bearings

Side view JSB 300 series - 13,50m Free span [1-100]

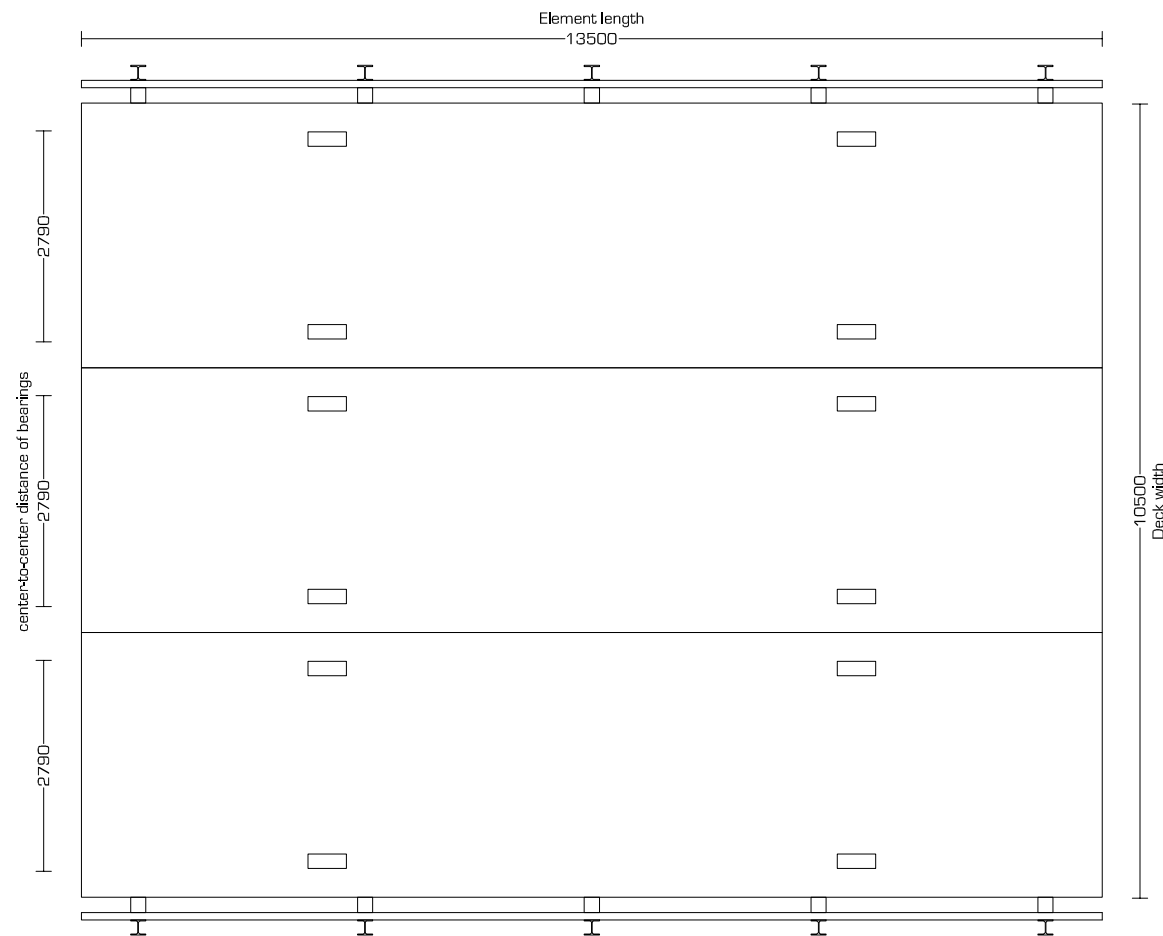

Top view JSB 300 series - 10,50m Deck width [1-100]

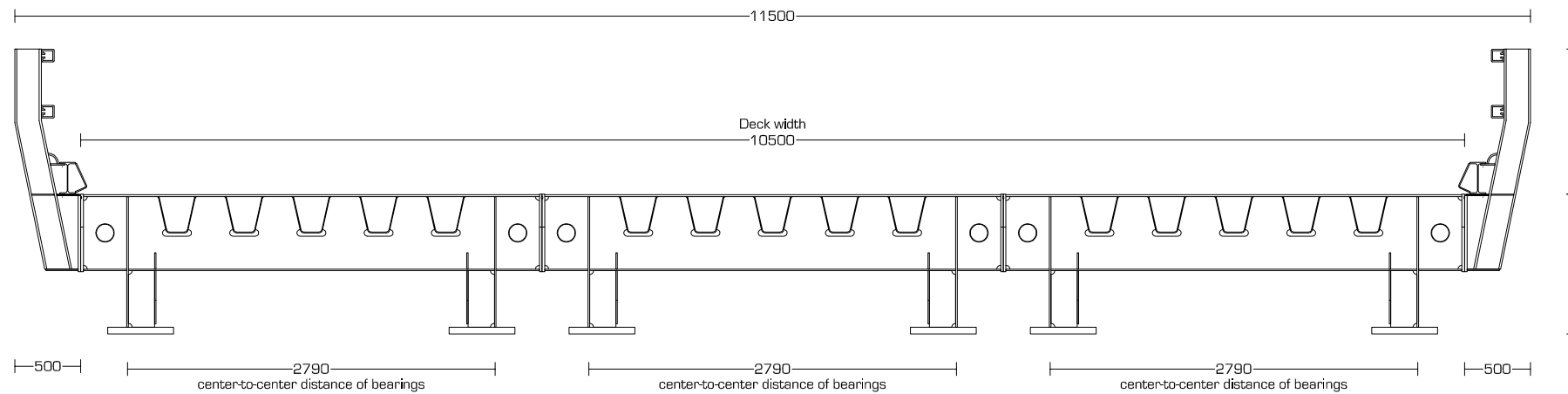

Cross view JSB 300 series - 1,06m Construction height [1-50]



Example

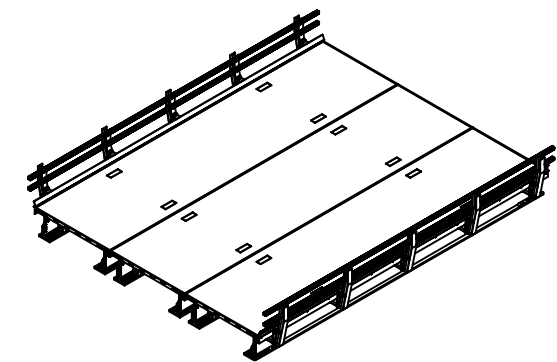

3D

- Element length: 13.500 mm
- Deck width: 10.500 mm
- Construction height: 1.060 mm
- Dead load: 64,2 t
- Load class: EuroCode
- Deck surface: Epoxy resin embedded with aggregate

EXAMPLE DRAWING			
		JANSONBRIDGING <small>COME ACROSS</small>	
www.jansonbridging.com			
JSB 300 series - 13,50m x 10,50m			
Code	Form	Date	Scale
1-100	1-50	2011-09-15	sc